



INVITATION FOR SEALED BID

BID 00-726

Description: Meter Box Rims

Department: PUBLIC WORKS

NIGP Commodity Code(s): 890-40-00-000-0

Total pages including this page is 15

Note: FAXING OF BID WILL NOT BE ACCEPTED

Important Instruction – Read Carefully:

If you have obtained these bid specifications from either of:
City of Tulsa's Fax-on-Demand (918-596-1171) or
City of Tulsa's Website : www.cityoftulsapurchasing.org

you must notify the buyer Patricia Cummings of your intent to bid by e-mail at pcummings@ci.tulsa.ok.us in order to receive addenda. The buyer will always acknowledge your e-mail for your records. All addenda will be posted on fax-on-demand and the website.

TABLE OF CONTENTS

Pay special attention to those pages with a reference to the following notes:

Note #1: Signature of authorized agent required

Note #2: Signature of an authorized agent and notarized required

Table of Contents		2
Invitation for Sealed Bid	(Note #1)	3
General Terms and Conditions		4
Interest Affidavit	(Note #2)	5
Bidder Affidavit	(Note #2)	6
Contractor Information Sheet		7
Summary Price Sheet		8
Specifications		9-15

Your bid response should follow the same format listed above plus any additional format requested in the body of the bid invitation.

**INVITATION FOR SEALED BIDS
TO
City of Tulsa**

200 CIVIC CENTER, ROOM 109, TULSA, OKLAHOMA 74103

Bid number and date of bid opening must appear on the lower
left outside corner of bid envelopes and all related containers.

DATE OF OPENING: January 25, 2001

BID NUMBER: **BID 00-726**

BID MUST BE IN THE CITY CLERK'S OFFICE AT THE ABOVE ADDRESS BY 5:00 P.M. THE DAY PRECEDING THE "DATE OF OPENING" SHOWN ABOVE.

BIDS WILL BE OPENED AT 8:30 A.M. IN THE CITY COUNCIL ROOM ON THE DAY SPECIFIED UNDER "DATE OF OPENING."

PUBLISHED IN THE TULSA DAILY COMMERCE AND LEGAL NEWS: January 10, 11, 12, 15, 16, 2001

Bid must be accompanied by bidder's bond, cashier's check or certified check in the amount of: None

PLEASE READ TERMS AND CONDITIONS ON THE NEXT PAGE BEFORE COMPLETING BID DOCUMENTS

THE FOLLOWING SECTION MUST BE COMPLETED BY BIDDER

Delivery will be made in not more than _____ days after receipt of order.

Payment terms _____ % _____ days.

City of Tulsa may increase quantity of order at the unit price bid for _____ days. (Bidder to Specify Days)
I have examined the terms and specifications and the instructions to bidders herein and agree, provided I am awarded a contract, to provide the above described items for the sum shown in accordance with the terms and specifications stated herein. All deviations are in writing and attached hereto.

Enclosed is a BID BOND ; CASHIER'S CHECK; Certified Check in the amount of \$ None, which I agree the City of Tulsa may retain as liquidated damages in the event of my failure to comply with the terms of this bid.

MUST BE SIGNED BY AUTHORIZED AGENT TO BE VALID

FIRM NAME _____ by _____

SIGNATURE OF AUTHORIZED AGENT

STREET _____ TITLE _____

CITY STATE _____ ZIP CODE _____ PHONE NUMBER _____ DATE _____

GENERAL TERMS AND CONDITIONS OF SEALED BIDS

THESE ITEMS APPLY TO AND BECOME A PART OF THE BID.

NO EXCEPTIONS TO THESE TERMS & CONDITIONS WILL BE CONSIDERED.

1. **BIDS MUST BE SUBMITTED ON THIS FORM ONLY INCLUDING A SIGNATURE OF AN AUTHORIZED AGENT.** Each bid shall be placed in a separate envelope. Be sure envelope is completely and properly identified and sealed, showing the bid number and date in the lower left hand corner. Bids must be time stamped in the office of the City Clerk by 5:00 P.M. on the day before date of opening.
2. No bidder may withdraw his proposal for a period of thirty (30) days after the date and hour set for the opening of bids.
3. All prices shall be quoted F.O.B. Tulsa, Oklahoma, and delivery to City of Tulsa location shall be without additional charge.
4. The bidder shall attach the manufacturer's name of the equipment or material to be furnished, type, model numbers, manufacturer's descriptive bulletins and specifications. All guarantees and warranties should be clearly stated. This data shall be in sufficient detail to describe accurately the equipment or material to be furnished. Manufacturer's specifications, in respect to the successful bidder, shall be considered as part of his contract with the City of Tulsa.
5. The bidder shall show in the proposal both the unit prices and total amount, where required, of each item listed. In the event of error or discrepancy in the mathematics, the unit prices shall prevail.
6. Any exceptions or deviations from written specifications shall be shown in writing and attached to the bid form.
7. Each bidder agrees to comply with the terms of Title 5, Chapter 1, of Tulsa, Oklahoma Charter and revised ordinances relating to equal employment opportunity.
8. **THE ENCLOSED FORMS REGARDING NON-COLLUSION AND FINANCIAL INTEREST MUST BE SIGNED, NOTARIZED, AND RETURNED WITH THE BID.**
9. The City of Tulsa reserves the right to reject any and all bids, to waive any technicalities in the bidding, and to award each item to different bidders or all items to a single bidder.
10. All bids must be accompanied by bidders bond, cash, certified or cashier's check in the amount shown on the face of the bid form. This amount shall be retained by the City of Tulsa as liquidated damages in the event the successful bidder (or bidders) fails to execute a contract, if required. The bidder agrees that said amount is presumed to be the damages sustained by the City due to the impracticability and extreme difficulty in fixing the actual damages. The office of the City Clerk will return the bid deposits to the unsuccessful bidders, after a contract has been awarded or all bids have been rejected.
11. In the event cash discounts are offered by the bidder, the discount date shall begin with the date of invoice, the date of receipt of all material covered by the purchase order, or the date of receipt by the City of Tulsa of the original copy of the purchase order with properly executed Affidavit of Claimant, whichever is the later date.
12. Direct purchase of certain items of equipment or material by the City of Tulsa are exempt from Federal Excise Tax and Oklahoma Sales Tax. In such cases the bidder shall quote prices which do not include Federal Excise Tax and Oklahoma Sales Tax. The City of Tulsa will furnish executed exemption certificates upon presentation by the bidder at the time of purchase.
13. Bid must show number of days required for delivery under normal conditions. Failure to state delivery time obligates bidder to complete delivery in fourteen (14) calendar days. Unrealistically short or long delivery promises may cause bid to be disregarded. Contractor must keep Purchasing Department advised at all times of status of order. Default in promised delivery or failure to meet specifications authorizes the Purchasing Agent to purchase supplies elsewhere and charge full increase of cost and handling to defaulting contractor. Consistent failure to meet delivery promises without valid reason may cause removal from bid list.
14. Bidder agrees to defend and save City of Tulsa from and against all demands, claims, suits, costs, expenses, damages and judgments based upon infringement of any patent relating to goods specified in this order or the ordinary use or operation of such goods by City or use or operation of such goods in accordance with bidders direction.
15. If the bid requires a written contract, the successful bidder shall execute a written contract with the City of Tulsa and return the required bonds and insurance certificates within ten (10) days after submission of contracts to said bidder by the City.

BIDDER AFFIDAVIT - TITLE 74 O.S. (1974 SUPP.) 85.22-85.25

STATE OF _____ COUNTY OF _____

_____, of lawful age, being first duly sworn on oath says

Authorized Agent

1. (s)he is the duly authorized agent of _____, the bidder submitting the competitive bid which is attached to this statement, for the purpose of certifying the facts pertaining to the existence of collusion among bidders and between bidders and municipal officials or employees, as well as facts pertaining to the giving or offering of things of value to government personnel in return for special consideration in the letting of any contract pursuant to the bid to which this statement is attached.
2. (s)he is fully aware of the facts and circumstances surrounding the making of the bid to which this statement is attached and has been personally and directly involved in the proceedings leading to the submission of such bid; and
3. neither the bidder nor anyone subject to the bidder's direction or control has been a party;
 - a. to any collusion among bidders in restraint of freedom of competition by agreement to bid at a fixed price or to refrain from bidding,
 - b. to any collusion with any municipal official or employee as to quantity, quality or price in the prospective contract, or as to any other terms of such prospective contract, nor
 - c. in any discussions between bidders and any municipal official concerning exchange of money or other thing of value for special consideration in the letting of a contract.

SIGNATURE OF AUTHORIZED AGENT

Subscribed and sworn to before me this _____ day of _____, 20_____.

Signature of Notary Public

MY COMMISSION EXPIRES

The Bidder Affidavit must be completed, signed by an authorized agent, and notarized.

CONTRACTOR/BIDDER INFORMATION SHEET

To be completed by all Bidders
For Contracts with the City of Tulsa
(Please print or type)

Project No. or Description _____

Full Name of Bidder _____

Legal Identity
(Corporation, Partnership,
Individual, etc.) _____

Address _____

Telephone No. _____

FAX No. _____

Taxpayer Identification Number _____

Contact Person _____

Phone No. _____

Fax No. _____

E-mail address _____

Webpage Address _____

Price Sheet Summary

Vendor Name: _____ Date: _____

Signature: _____

You will be able to obtain a copy of the Bid Summary on the City of Tulsa's Purchase-Net Fax-on-Demand and Website shortly after bid opening.

BID 00-726 Meter Box Rims Public Works Department

Item	Qty.	Description	Price Each
(1)	1,500 or more	Meter Can with Rim for ¾" Service (Without Lid)	\$ _____

Specify brand: _____

TOTAL BID: \$ _____

BID 00-726
Meter Box Rims
PUBLIC WORKS DEPARTMENT

INTENT:

THE INTENT OF THESE SPECIFICATIONS IS TO SECURE, ON A COMPETITIVE BASIS, A SOURCE TO **SUPPLY METER BOX RIMS** FOR THE CITY OF TULSA'S PUBLIC WORKS DEPARTMENT.

PRICING:

PRICES BID SHALL BE FIRM AND INCLUDE ANY APPLICABLE FREIGHT CHARGES.

SPECIFICATIONS:

METER BOX RIMS SHALL BE IN ACCORDANCE WITH THE ATTACHED STANDARD DRAWING(S). METER BOX RIMS SHALL BE MADE OF CLASS 30A OR 30B IRON AND CONFORM WITH THE STANDARD SPECIFICATIONS FOR GRAY IRON CASTINGS ASTM A48.

CASTINGS SHALL BE STRONG WITH EVEN GRAIN, SMOOTH, FREE FROM SCALE, BLISTERS, SAND HOLES AND OTHER DEFECTS WHICH WOULD MAKE THEM UNFIT FOR THE INTENDED USE. CASTINGS SHALL BE MADE ACCURATELY TO DIMENSIONS SHOWN AND SHALL BE PLANED OR GROUND WHERE MARKED OR WHERE OTHERWISE NECESSARY TO SECURE PERFECTLY FLAT AND TRUE SURFACES. ALLOWANCES SHALL BE MADE IN THE PATTERNS SO THAT THE SPECIFIED THICKNESS SHALL NOT BE REDUCED.

THE MINIMUM WEIGHT OF **15 LBS.** MUST BE STRICTLY ADHERED TO. RIMS FAILING TO MEET THESE MINIMUM WEIGHTS SHALL NOT BE ACCEPTED.

ALL STEEL METER BOXES SHALL BE IN ACCORDANCE WITH THE ATTACHED STANDARD DETAIL, AND SHALL BE GALVANIZED. METER CAN FOR ¾" SERVICE-BASS & HAYS 34B. METER BOX AND RIM MUST BE ASSEMBLED.

BIDDER'S AFFIDAVIT:

EACH BIDDER SHALL ACCOMPANY THEIR BID WITH A FULLY EXECUTED AND NOTARIZED COPY OF THE ATTACHED **NON-COLLUSION AFFIDAVIT**

AND THE **INTEREST AFFIDAVIT**. FAILURE TO DO SO MAY BE CAUSE FOR REJECTION OF THE BID.

METHODS OF SAMPLING, INSPECTIONS & TESTS:

1. AFTER BID RESULTS ARE TABULATED, THE CITY OF TULSA PURCHASING DIVISION RESERVES THE RIGHT TO REQUIRE SAMPLES OF SELECTED EQUIPMENT AND/OR PRODUCTS FOR INSPECTION AND EVALUATION.
2. UNLESS OTHERWISE SPECIFIED IN THE CONTRACT OR PURCHASE ORDER, THE SUPPLIER SHALL BE RESPONSIBLE FOR THE PERFORMANCE OF ALL INSPECTION AND TEST REQUIREMENTS NECESSARY TO INSURE COMPLIANCE WITH REQUIREMENTS FOR THIS SPECIFICATION. THIS DOES NOT PRECLUDE SUBSEQUENT INSPECTION AND TESTIMONY BY THE CITY OF TULSA TO FURTHER DETERMINE CONFORMANCE WITH SPECIFICATION REQUIREMENTS OF QUALITY STANDARDS OF WORKMANSHIP, MATERIAL AND CONSTRUCTION TECHNIQUES.

ADDENDA AND INTERPRETATIONS:

IF IT BECOMES NECESSARY TO REVISE ANY PART OF THIS BID, A WRITTEN ADDENDUM WILL BE PROVIDED TO ALL THE BIDDERS. THE CITY OF TULSA IS NOT BOUND BY ANY ORAL REPRESENTATION, CLARIFICATIONS OR CHANGES MADE IN THE WRITTEN SPECIFICATIONS BY CITY OF TULSA EMPLOYEES UNLESS SUCH CLARIFICATION OR CHANGE IS PROVIDED TO BIDDERS IN WRITTEN ADDENDUM FORM FROM THE PURCHASING DIVISION.

ALTERING BIDS:

BIDS CANNOT BE ALTERED OR AMENDED AFTER SUBMISSION DEADLINE. ANY INTERLINEATION, ALTERATION, OR ERASURE MADE BEFORE OPENING TIME AND DATE MUST BE INITIALED BY THE SIGNER OF THE BID, GUARANTEEING AUTHENTICITY. BIDS MUST BE SUBMITTED IN INK OR TYPEWRITTEN, PENCILING WILL NOT BE ACCEPTED.

TESTS:

THE CITY RESERVES THE RIGHT TO SUBJECT ALL PRODUCTS OFFERED, PRIOR TO AWARD OF BID, TO WHATEVER PHYSICAL AND OR CHEMICAL TESTS ARE DEEMED NECESSARY TO SATISFY THE PURPOSE FOR WHICH THEY ARE REQUIRED.

IF ADDITIONAL SAMPLES ARE REQUIRED TO COMPLETE SUCH TESTS, THEY SHALL BE SUPPLIED BY THE BIDDER AT NO ADDITIONAL COST.

DESCRIPTIVE LITERATURE:

EACH BIDDER IS REQUIRED TO FURNISH WITH THEIR BID, CATALOG CUTS AND/OR DESCRIPTIVE LITERATURE, PROPERLY LABELED WITH THE BID NUMBER AND BIDDER'S NAME, WITH FULL ILLUSTRATIONS AND DETAILED SPECIFICATIONS FOR EACH ITEM OFFERED AS EQUAL TO THE BRAND NAME SPECIFIED. IN ADDITION, **ALL DIFFERENCES IN SPECIFICATIONS FROM THE SPECIFICATIONS STATED HEREIN MUST BE SO MARKED.** DESCRIPTIVE LITERATURE IS REQUIRED TO ESTABLISH, FOR THE PURPOSE OF BID EVALUATION AND AWARD, DETAILS OF THE PRODUCT(S) THE BIDDER PROPOSES TO FURNISH AS TO DESIGN, MATERIALS, METHOD OF MANUFACTURE, CONSTRUCTION, ASSEMBLY OR OPERATION, AS APPROPRIATE. **FAILURE TO SUBMIT THE DESCRIPTIVE LITERATURE MAY BE CAUSE FOR REJECTION OF YOUR BID.**

AMERICANS WITH DISABILITIES ACT:

THE CONTRACTOR SHALL TAKE THE NECESSARY ACTIONS TO ENSURE ITS FACILITIES AND EQUIPMENT ARE IN COMPLIANCE WITH THE REQUIREMENTS OF THE AMERICANS WITH DISABILITIES ACT. IT IS UNDERSTOOD THAT THE PROGRAM OF THE CONTRACTOR IS NOT A PROGRAM OR ACTIVITY OF THE CITY OF TULSA. THE CONTRACTOR AGREES THAT ITS PROGRAM OR ACTIVITY WILL COMPLY WITH THE REQUIREMENTS OF THE ADA. ANY COSTS OF SUCH COMPLIANCE WILL BE THE RESPONSIBILITY OF CONTRACTOR. UNDER NO CIRCUMSTANCES WILL CONTRACTOR CONDUCT ANY ACTIVITY WHICH IT DEEMS TO NOT BE IN COMPLIANCE WITH THE ADA.

EMPLOYMENT DISCRIMINATION BY CONTRACTOR PROHIBITED:

A. DURING THE PERFORMANCE OF THIS CONTRACT, THE CONTRACTOR AGREES AS FOLLOWS:

- (1) THE CONTRACTOR WILL NOT DISCRIMINATE AGAINST ANY EMPLOYEE OR APPLICANT FOR EMPLOYMENT BECAUSE OF RACE, RELIGION, COLOR, SEX OR NATIONAL ORIGIN, EXCEPT WHERE RELIGION, SEX OR NATIONAL ORIGIN IS A BONA FIDE OCCUPATIONAL QUALIFICATION REASONABLY NECESSARY TO THE NORMAL OPERATION OF THE CONTRACTOR. THE CONTRACTOR AGREES TO POST IN CONSPICUOUS PLACES, AVAILABLE TO EMPLOYEES AND APPLICANTS FOR EMPLOYMENT, NOTICES SETTING FORTH THE PROVISION OF THIS NON-DISCRIMINATION CLAUSE.

(2) THE CONTRACTOR, IN ALL SOLICITATIONS OR ADVERTISEMENTS FOR EMPLOYMENT PLACED BY OR ON BEHALF OF THE CONTRACTOR, WILL STATE THAT SUCH CONTRACTOR IS AN EQUAL OPPORTUNITY EMPLOYER.

(3) NOTICES, ADVERTISEMENTS AND SOLICITATIONS PLACED IN ACCORDANCE WITH FEDERAL LAW, RULE OR REGULATION SHALL BE DEEMED SUFFICIENT FOR THE PURPOSE OF MEETING THE REQUIREMENTS OF THIS SECTION.

B. THE CONTRACTOR WILL INCLUDE THE PROVISION OF THE FOREGOING PARAGRAPHS OF THIS SECTION IN EVERY SUBCONTRACT OR PURCHASE ORDER OF OVER \$10,000, SO THAT THE PROVISIONS WILL BE BINDING UPON EACH SUBCONTRACTOR OR VENDOR.

AWARD OF BID:

THE BID SHALL BE AWARDED TO THE FIRM WHOSE PROPOSAL IS RESPONSIVE TO THE BID AND IS MOST ADVANTAGEOUS TO THE CITY, CONSIDERING THE FACTORS IDENTIFIED IN THE BID AND SECTION 406E OF TITLE 6, THE PURCHASING ORDINANCE SET FORTH BELOW:

E. AWARD OF CONTRACT.

1. AUTHORITY OF MAYOR. THE MAYOR SHALL HAVE THE AUTHORITY TO AWARD CONTRACTS WITHIN THE PURVIEW OF THIS CHAPTER.

2. LOWEST SECURE BIDDER. CONTRACTS SHALL BE AWARDED TO THE LOWEST SECURE BIDDER MEETING SPECIFICATIONS. IN DETERMINING "LOWEST SECURE BIDDER", IN ADDITION TO PRICE, THE FOLLOWING FACTORS SHALL BE CONSIDERED:

A. THE ABILITY, CAPACITY AND SKILL OF THE BIDDER TO PERFORM THE CONTRACT OR PROVIDE THE SERVICE REQUIRED;

B. WHETHER THE BIDDER CAN PERFORM THE CONTRACT OR PROVIDE THE SERVICE PROMPTLY OR WITHIN THE TIME SPECIFIED, WITHOUT DELAY OR INTERFERENCE;

C. THE CHARACTER, INTEGRITY, REPUTATION, JUDGMENT, EXPERIENCE AND EFFICIENCY OF THE BIDDER;

D. THE QUALITY OF PERFORMANCE OF PREVIOUS CONTRACTS OR SERVICES;

E. THE PREVIOUS AND EXISTING COMPLIANCE BY THE BIDDER WITH LAWS AND ORDINANCES RELATING TO THE CONTRACT OR SERVICE;

F. THE SUFFICIENCY OF THE FINANCIAL RESOURCES AND ABILITY OF THE BIDDER TO PERFORM THE CONTRACT OR PROVIDE THE SERVICE;

G. THE QUALITY, AVAILABILITY AND ADAPTABILITY OF THE SUPPLIES OR CONTRACTUAL SERVICES TO THE PARTICULAR USE REQUIRED;

H. THE ABILITY OF THE BIDDER TO PROVIDE FUTURE MAINTENANCE AND SERVICE FOR THE USE OF THE SUBJECT OF THE CONTRACT, AND;

I. WHERE AN EARLIER DELIVERY DATE WOULD BE OF GREAT BENEFIT TO THE REQUISITIONING AGENCY, THE DATE AND TERMS OF DELIVERY MAY BE CONSIDERED IN THE BID AWARD, AND;

J. THE NUMBER AND SCOPE OF CONDITIONS ATTACHED TO THE BID.

K. IF A POINT SYSTEM HAS BEEN UTILIZED IN THE BID SPECIFICATIONS, THE NUMBER OF POINTS EARNED BY THE BIDDER.

BID DOCUMENTS:

BIDDER SHALL RETURN ALL BID DOCUMENTS INTACT EXACTLY AS FURNISHED IN ITS ORIGINAL FORM. ALL BID DOCUMENTS REQUIRING SIGNATURE MUST BE SIGNED BY AN AUTHORIZED AGENT OF THE COMPANY BIDDING. PRINTING YOUR NAME IN LIEU OF SIGNATURE WILL NOT BE ALLOWED. **FAILURE TO COMPLY WILL RESULT IN REJECTION OF YOUR BID.**

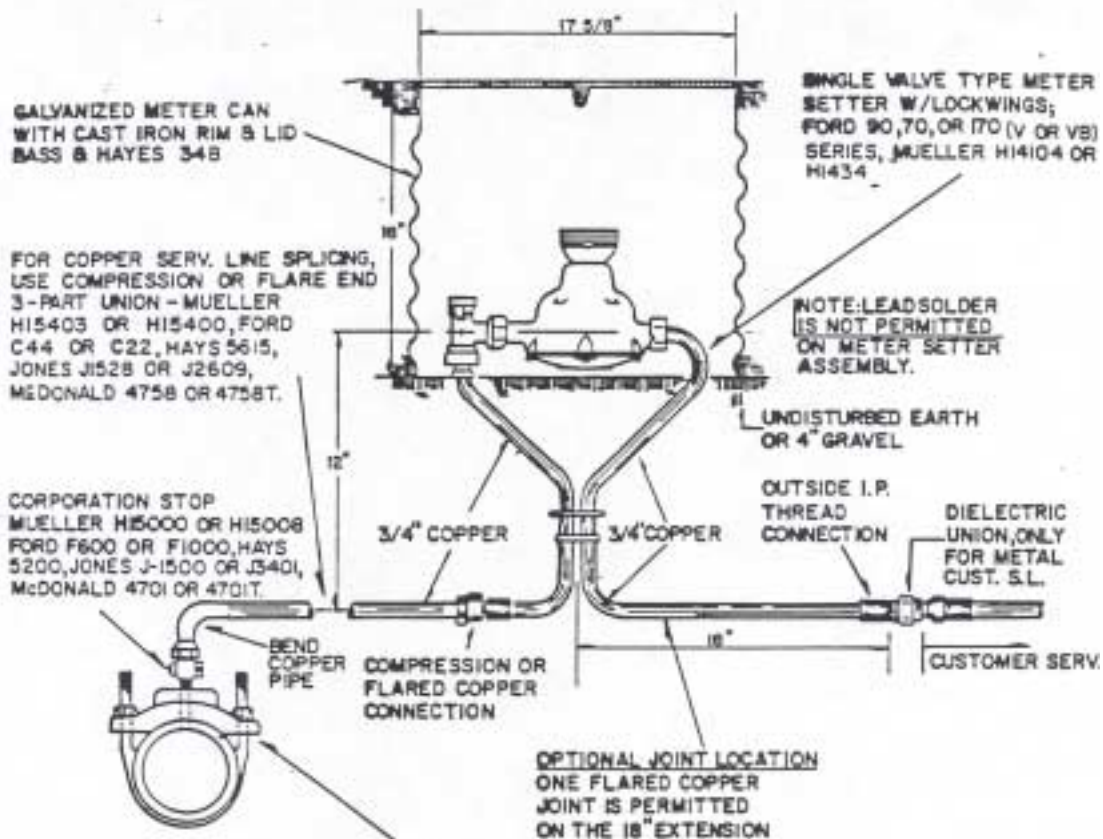

SERVICE CLAMP
 TAP ON D.I.P. - FORD STYLE F102, MUELLER H10400 SERIES
 TAP ON R.V.C. - FORD STYLE S90, MUELLER H13400 SERIES, POWERSEAL 3405

- NOTES:**
1. SERV. CLAMP REQUIRED FOR ALL SIZES PVC, & FOR 4" & SMALLER IRON. FOR 6" & LARGER IRON TAP DIRECTLY.
 2. TAP AT ANGLE NECESSARY TO PROVIDE 30" OF COVER OVER THE SERVICE LINE.
 3. COPPER SERVICE LINES SHALL BE TYPE K SOFT ANNEALED.



STANDARD METER SETTING FOR 5/8" x 3/4" AND 3/4" WATER SERVICE	
CITY OF TULSA, OKLAHOMA WATER AND SEWER DEPARTMENT	
DRAWN BY: BRW	APPROVED:
DATE: 4/27/87	
REV.	SUPT. W&S DEPT.
NOT TO SCALE	DATE:
STANDARD NO. 29	

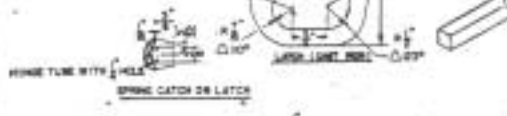
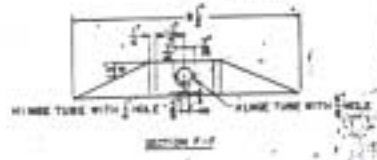
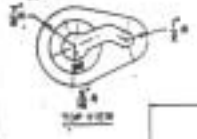
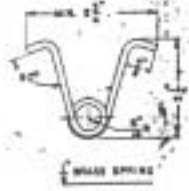
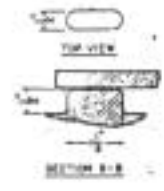
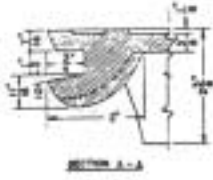
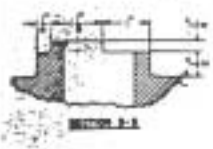
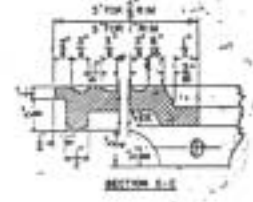
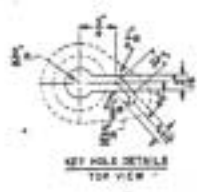
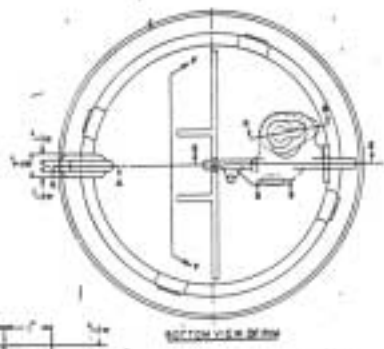
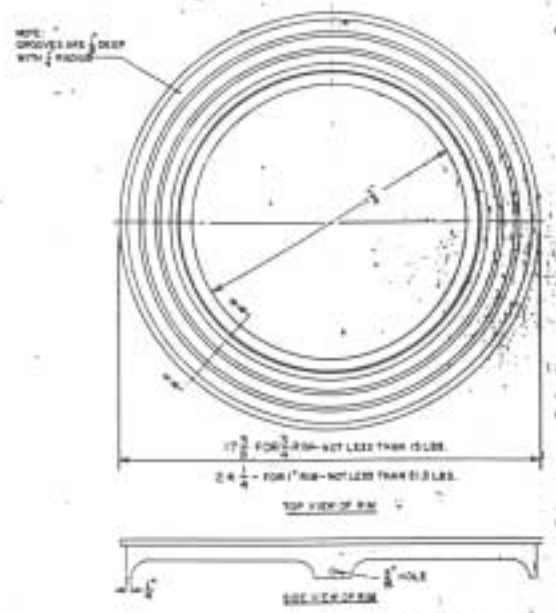
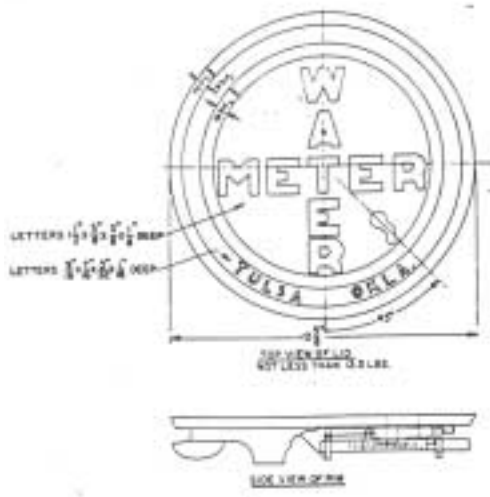

MINIMUM SIZE OF LATCH

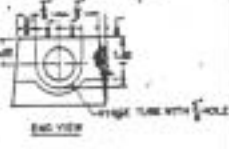
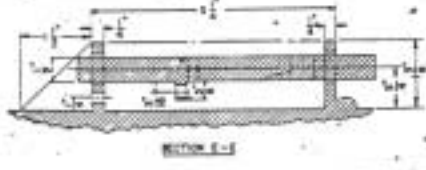

STANDARD DETAIL FOR $\frac{3}{4}$ " & 1" METER PIT RIMS & LID	
CITY OF TULSA, OKLAHOMA WATER & SEWER DEPARTMENT	
DRAWN BY - D.E.H.	APPROVED
DATE - 5-13-85	SUP.
CHECKED BY - R.W.M. 4-24-85	DATE - 4/2
NOT TO SCALE	
STANDARD NO. 31	